

Instruction Manual

MultiLite Digital Temperature Scanner Indicator



PMD-MXT Series

Instruction Manual - PMD-MXT Scanning Indicator

Part Number Configurator:

Model	Input Channels	Input Type
PMD-MXT	-XX	-XXX
	08 8 channels	RTD RTD
	16 16 channels	THC Thermocouple
	24 24 channels	
	32 32 channels	

Ordering Example

PMD-MXT-24-RTD: 24 input channels, RTD Input

Rear Panel Schematic:

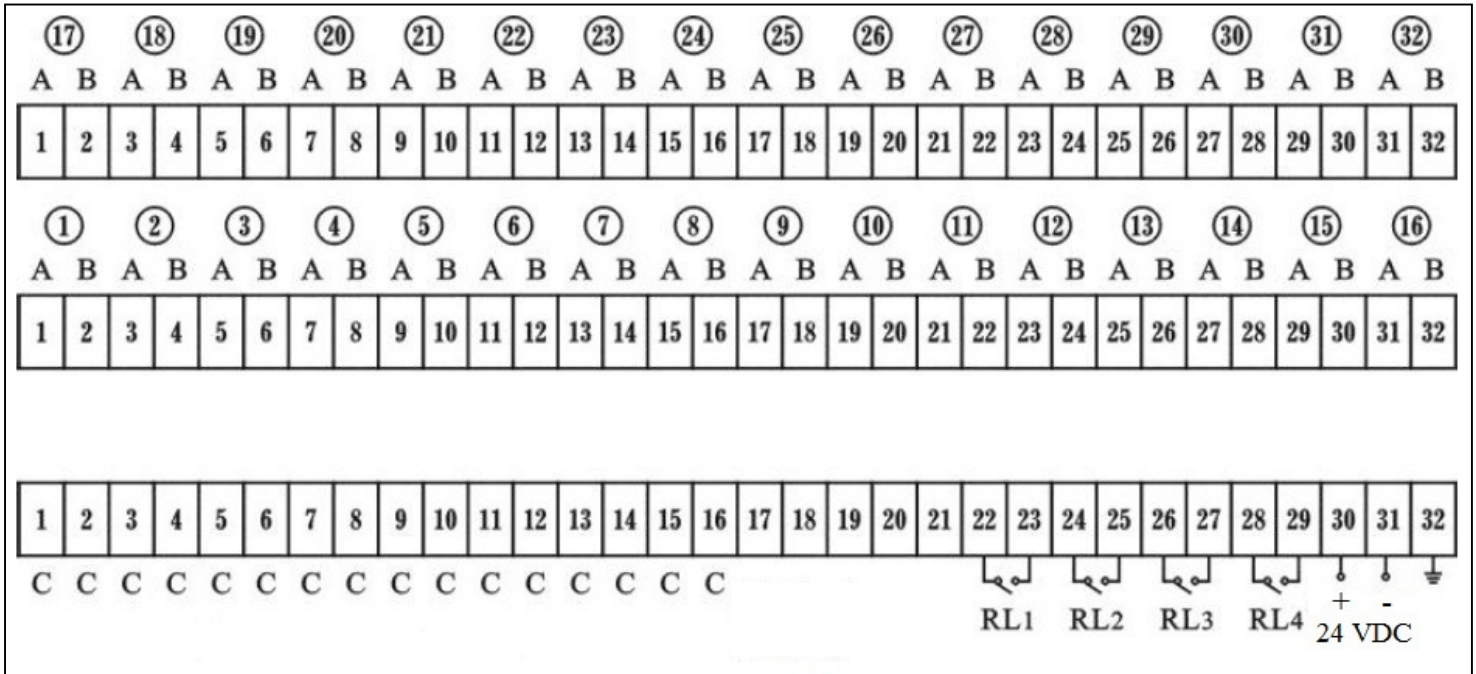

Instruction Manual - PMD-MXT Scanning Indicator

Power Supply Wiring:

Use: 24 VDC Power Supply

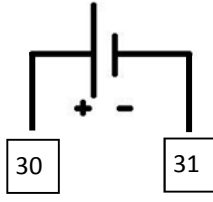

Signal Wiring:

Thermocouple



2-Wire RTD

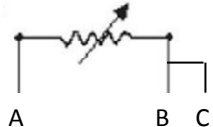

3-Wire RTD

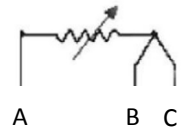

DC Voltage

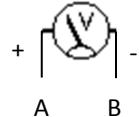

DC Current

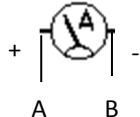

Meter Dimensions (mm):

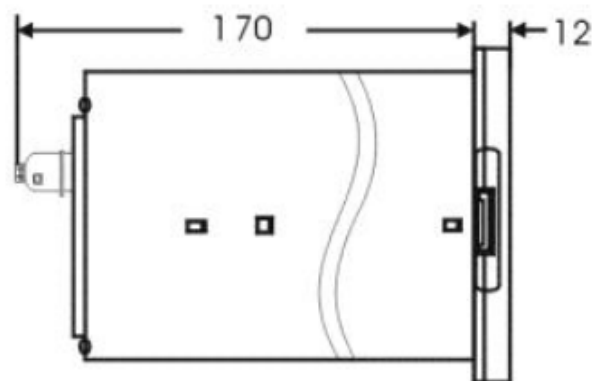
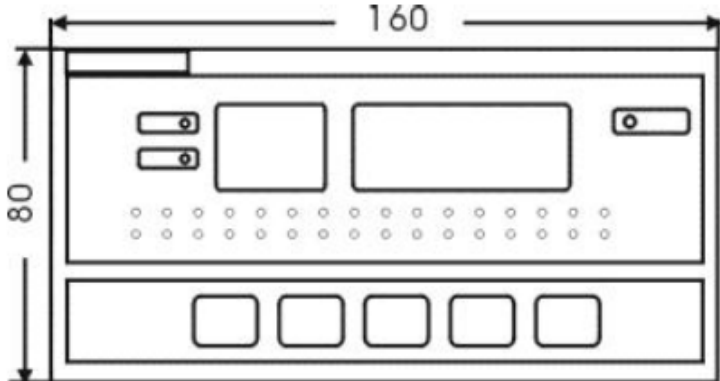

Cutout Dimensions (mm):

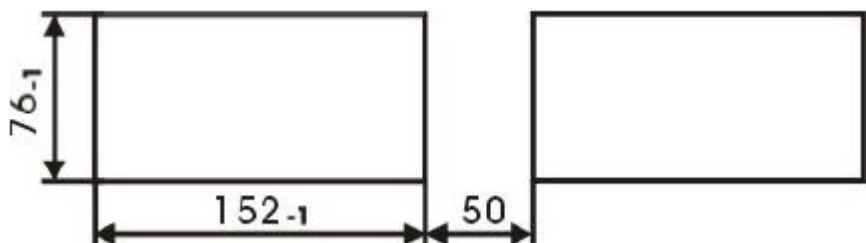

Instruction Manual - PMD-MXT Scanning Indicator

Faceplate:

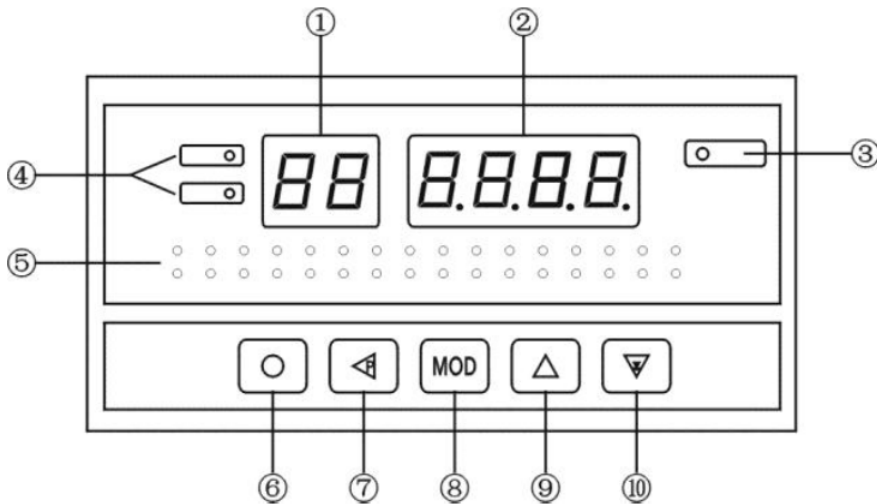

Push Button Functions:

①	Channel Select Indication
②	Measured Value Indication
③	External Printer Communications Indicator (LED) (* If option is installed)
④	Master Alarms Indicators (LED)
⑤	Individual Channel Alarm Indicators (LED) LED Status: Lit = Alarm Warning, Unlit = No Alarm, Flashing = Nearing Alarm Warning
⑥	Function Key
⑦	Program Key
⑧	Modify Key (Enter)
⑨	Increase Key
⑩	Decrease Key, Alarm Mute

Instruction Manual - PMD-MXT Scanning Indicator

Choose Auto Scanning / Manual Scanning Mode Function :

The instrument powers up in Auto Scanning mode. To change to Manual Scanning mode:

Press **MOD** key x1 to enter Manual Scanning mode.

The Channel Selection Indication will begin flashing. Use the **▲** or **▼** keys to display desired channel.

To return to instrument Auto Scanning Mode press **MOD** key x1.

Changing a Channel's Alarm Set-point Parameter Setting:

NOTE: The instrument has (4) user selectable alarm set-points **AH & AL & bH & bL**

Press **MOD** key x1 to enter Manual Scanning mode.

The Channel Selection Indication will begin flashing. Use the **▲** or **▼** keys to display desired channel.

Press & hold the **●** key for 3 seconds

The Channel Selection Indication will display **AH** & the channel number. Now press the **←** key x1

The Measured Value Indication will display the current alarm set-point value for **AH**

Pressing the **MOD** key x1 will sequence to the **AL** alarm set-point value

Pressing the **MOD** key x1 will sequence to the **bH** alarm set-point value

Pressing the **MOD** key x1 will sequence to the **bL** alarm set-point value

To change the channel's alarm set-point value

Once the desired **AH** or **AL** or **bH** or **bL** parameter is selected press the **←** key x1

The current alarm set-point will flash in the Measured Value Indication window

Change the value to the desired alarm set-point using the **←** **▲** **▼** keys

Press the **MOD** x1 to store the new alarm set-point value

To return to Manual Scanning Mode press and hold the **●** key for 6 seconds

HINT: Time saving shortcut to copy a channel's parameter settings to the next channel

EXAMPLE: Copy Channel 1 **AH** setting of 900 from Channel 1 to Channel 2 and all the way up to Channel 16

Set **AH01** parameter to 900 then continually press the **MOD** key until **AH** is displayed again. Then press the **←** key x1

When **AH01** is displayed press the **▲** key x1, the display will now read **AH02** and the setting of 900 will have been copied

Press the **▲** key again and **AH03** will be displayed. Keep pressing the **▲** key until **AH 16** is displayed

All 16 channels **AH** settings are now 900

Instruction Manual - PMD-MXT Scanning Indicator

Changing a Channel's Input Type & Scale Factor:

To change a channel's Input Type & Scale Factor, a security access code must be entered.

Follow these instructions:

Press  key x1 to enter Manual Scanning mode.

The Channel Selection Indication will begin flashing. Use the or keys to display the desired channel



Press & hold the  key for 3 seconds



The Channel Selection Indication will display 

Press & hold the  key for 3 seconds



The Measured Value indication will display 

Press the  key x1 until 0000 is in the Measured Value Indication window

Change the value to 1111 using the    keys

Press  key x1 the Measured Value indication will display 

Press & hold the  key for 3 seconds

Use the  or  keys to choose the channel to be modified

Press & hold the  key for 3 seconds

The Channel Selection Indication will display  and in the Measured Value Indication window will be the channel number



The instrument is now in the programming mode

Press  key to increment through the Channel Input Type & Scale Factor settings

Reference: [Table 1] Channel Input Type & Scale Factor Settings

To Modify a Channel's Input Type or Scale Factor follow these instructions:

Once at the desired Channel's Input Type or Scale Factor parameter is in the display, Press the  key to access the parameter

Use the    arrow keys to modify the parameter value

Press the  key to save the new parameter value & move to the next Advanced Function parameter

To exit & return to Manual Scanning Mode press and hold the  key for 6 seconds

Instruction Manual - PMD-MXT Scanning Indicator

Channel Input Type & Scale Factor Settings Table:

[Table 1] Channel Input Type & Scale Factor Settings

Displayed Value	Function	Comment	Note
AH	Alarm AH Set-point Value	Enter alarm #1 trip point value	
AL	Alarm AL Set-point Value	Enter alarm #2 trip point value	
bH	Alarm bH Set-point Value	Enter alarm #3 trip point value	
bL	Alarm bL Set-point Value	Enter alarm #4 trip point value	
CA	Zero Offset Correction Value	Default = 0000	1
FC	Full Scale Offset Correction Value	Default = 1.000	1
ct	Input Signal Type	See [Table 3] Input Type Options	
cd	Decimal Point Position	0.000, 00.00, 000.0, or 0000 (Default = 0000)	2
ur	Input Low Value	Default = 0	3
fr	Input High Value	Default = 3000	3
dy	Engineering Unit Selection	See [Table 2] Engineering Unit Selections	
tb	Digital Filtering Time Coefficient	Default = 0001	

Note 1: Corrected Measured Value = $FC \times (\text{Measured Value} + CA)$

HINT: To display in °F $FC = 1.8$ and $CA = 32$

Note 2: RTD input: only 000.0 (0.1°C), Thermocouple input: only 0000 (1°C) or 000.0 (0.1°C)

Note 3: Does not apply to Thermocouple or RTD inputs, Voltage or Current inputs only

[Table 2] Engineering Unit Selections

0	1	2	3	4	5	6	7	8	9
	°C	%RH	%	Pa	kPa	MPa	t/h	m3/h	l/m
10	11	12	13	14	15	16	17	18	19
m	Mm	Kg	t	kN	V	A	PPm	Mbar	bar

Instruction Manual - PMD-MXT Scanning Indicator



[Table 3] Input Type Options

No.	Displayed Value	Input Signal
0	.off	Not in Use
1	P 100	RTD PT100
2	c 100	RTD Cu100
3	cu50	RTD Cu50
4	.bA1	RTD BA1
5	.bA2	RTD BA2
6	.G53	RTD G53
7	...K	Thermocouple Type K
8	...S	Thermocouple Type S
9	...r	Thermocouple Type R
10	...b	Thermocouple Type B
11	...n	Thermocouple Type N
12	...E	Thermocouple Type E
13	...J	Thermocouple Type J
14	...t	Thermocouple Type T
15	4-20	DC current; 4-20 mA
16	0-10	DC current; 0-10 mA
17	0-20	DC current; 0-20 mA
18	1-5v	DC voltage; 1-5V
19	0-5v	DC voltage; 0-5V

Advanced Functions:

To access the Advanced Functions follow these instructions:

Press  key x1 to enter Manual Scanning mode.

The Channel Selection Indication will begin flashing. Use the  or  keys to display the desired channel



Press & hold the  key for 3 seconds



The Channel Selection Indication will display 

Press & hold the  key for 3 seconds

The Measured Value indication will display 

Press the  key x1 until 0000 is in the Measured Value Indication window

Change the value to 1111 using the    keys

Press  key x1 the Measured Value indication will display 

Press  key x1 the Channel Selection indication will display 



The instrument is now in the programming mode

Press  key to increment through the Advanced Functions settings

Reference: [Table 4] Advanced Functions

To Modify an Advanced Function follow these instructions:

Once at the desired Advanced Function parameter is in the display, Press the  key to access the parameter

Use the    arrow keys to modify the parameter value

Press the  key to save the new parameter value & move to the next Advanced Function parameter

To exit & return to Manual Scanning Mode press and hold the  key for 6 seconds

Instruction Manual - PMD-MXT Scanning Indicator

Advanced Functions Table:

[Table 4] Advanced Functions

Displayed Value	Function	Comment
ct	Channel Indication Switching Time Setting	When in Auto Scanning Mode, Range 0.5~10.0 seconds
cH	Channel Number	<i>*For factory use only* *DO NOT CHANGE*</i>
Ld	Cold Junction Compensation Mode Setting	<i>*For factory use only* *DO NOT CHANGE*</i> (Default = 61)
Lc	Cold Junction Compensation Coefficient	<i>*For factory use only* *DO NOT CHANGE*</i> (Default = 1.00)
F1	Alarm Type AH	H = High Alarm, L = Low Alarm (Default = H)
F2	Alarm Type AL	H = High Alarm, L = Low Alarm (Default = L)
F3	Alarm Type bH	H = High Alarm, L = Low Alarm (Default = H)
F4	Alarm Type bL	H = High Alarm, L = Low Alarm (Default = L)
H1	Alarm AH Hysterisis	Default = 0
H2	Alarm AL Hysterisis	Default = 0
At	Alarm Delay Time	Default = 0, Range 0~50 seconds *Set at 51 to make alarm latching type, press  to reset
Ad	RS-485 Address (<i>* if option is installed</i>)	<i>*For factory use only* *DO NOT CHANGE*</i> (Default = 1)
bd	RS-485 Baud Rate (<i>* if option is installed</i>)	Default = 9600 Range: 2400, 4800, 9600, 19.2k

Instruction Manual - PMD-MXT Scanning Indicator

Technical Specifications:

Input type:

Thermocouple K, T, J, B, E, N, R, S
RTD PT100, CU100, CU50

Accuracy:

RTD: +/- 1.0% of full scale
Thermocouple: +/- 0.3% of full scale

Resolution:

RTD (0.1° Res): -167.9 to +999.9°F (-189.9 to +596.9°C)
TC (0.1° Res): -167.9 to +999.9°F (-199.9 to +999.9°C)
TC (1° Res): -412 to 3271°F (-257 to 1800°C)

Display:

4-digit LED, 0.56 inch (14 mm high)

Sample Rate:

0.1 second per channel

Power:

20 to 28 VDC @ 400 mA (nominal)

Dimensions:

6.3 inch x 3 inch x 7 inch (160 mm x 80 mm x 182 mm)
(Cutout: 6 inch x 3 inch (152 mm x 76 mm))

Weight:

2 pounds (900 grams)

Relay contact:

250 VAC @ 2 amps (resistance load)

Environment:

0 to 50°C, 90% Max. RH (non-condensing)